



# TABLE OF CONTENTS

Glossary of Terms.....	4
Parts .....	4
Hardware .....	5
Accessories .....	5
Inventory .....	6
Basic Assembly / Connections.....	8
Plane to Plane .....	8
Plane to Pedestal.....	8
Post to Parklet Bracket.....	9
Plane to Parklet Railing .....	9
Post to Bike Lane Bracket.....	9
Table Top to Post .....	10
Flag to Bollard.....	10
Tape Down .....	11
Creative Crosswalk.....	14
Separated Bike Lane .....	18
Curb Extension .....	22
Parklet .....	26
Pedestrian Island .....	30
Storage .....	32
Contacts.....	34

# GLOSSARY OF TERMS

---

## Parts

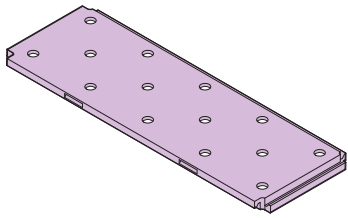

1. Plane

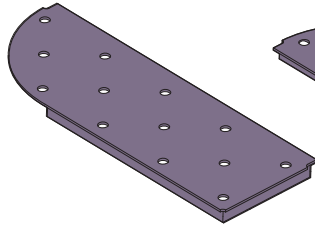

2. End Plane  
(Parklet, left)

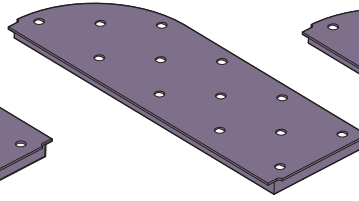

3. End Plane  
(Parklet, Right)

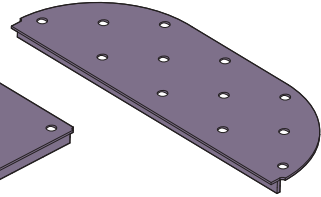

4. Nose Plane  
(Ped. Island)

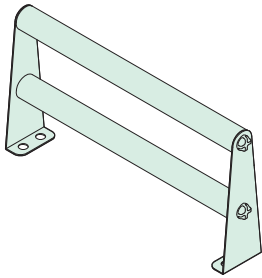

5. Parklet Railing

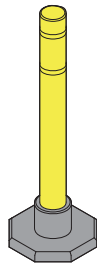

6. Stanchion

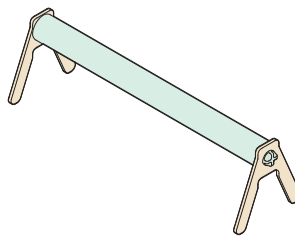

7. Bike Lane Railing

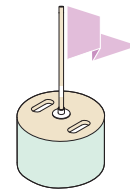

8. Bike Lane Bollard



9. Bike Lane Marker

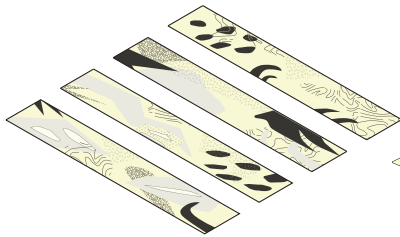

10. Decorative  
Crosswalk Strips

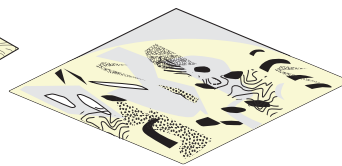

11. End Mesh  
(Bulb out)

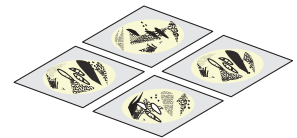

12. Circles (Bulb Out)



13. Shark teeth (Crosswalk)

---

## Hardware

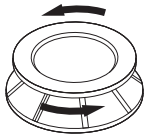

14. Pedestal

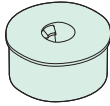

15. Threaded cap



16. Screw

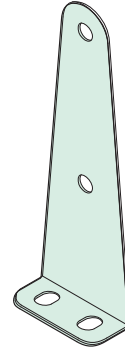

17. Parklet Bracket

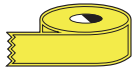

18. Tape



19. Post

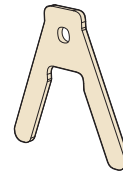

20. Bike Lane Bracket

---

## Accessories

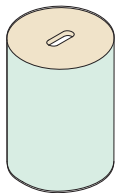

21. Bollard

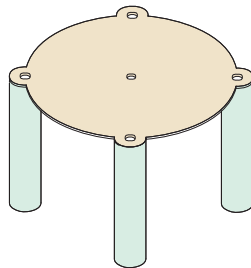

22. Cafe Table

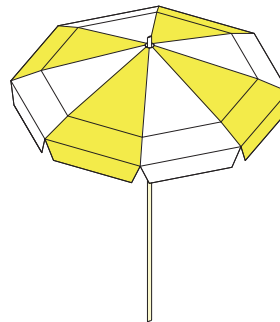























23. Umbrella



23. Treatment Sign

# INVENTORY

MATERIAL	IMAGE	DIM.	QUANTITY PER KIT	PARKLET
1. Plane		6' x 2'	30	9
2. End Plane, left		6' x 2'	1	1
3. End Plane, right		6' x 2'	1	1
4. Nose Plane		6' x 2'	2	
5. Long Parklet Railing		6' x 30"	3	3
6. Short Parklet Railing		4' x 30"	2	2
7. Stanchion			13	4
8. Bike Lane Railing		6' x 20"	20	
9. Bike Lane Bollard			20	
10. Bike Lane Marker		6' x 3'	1	
11. Crosswalk Strips		11' x 3'	12	
12. End Mesh		6' x 6'	2	
13. Circles		3' x 3'	9	
14. Shark Teeth		2' x 11'	1	
15. Pedestal			135	54
16. Threaded Cap			6	6
17. Screw			10	10
18. Tape			X	
19. Bollard			8	8
20. Cafe Table			2	2
21. Cafe Umbrella			2	2
22. Sign			5	1

CURB EXTENSION	MEDIAN REFUGE ISLAND	CREATIVE CROSSWALK	SEPARATED BIKE LANE
12	9		
	2		
3	6		
			20
			20
			1
		12	
2			
9			
		1	
42	39		
		x	x
1	1	1	1

# BASIC ASSEMBLY / CONNECTIONS

---

The Go Human Kit of Parts is made up of foundational parts, hardware, and accessories that assemble to form the 5 street treatments of a parklet, bulb out, median refuge island, decorative crosswalk, and separated bike lane. In the section below, you will find descriptions and diagrams of how the various pieces connect to create the base of each street treatment. Later in the guide, we will describe each street treatment individually as well as their specific installation requirements.

## Plane to Plane

The plane is a 6' by 2' hollowed plastic piece. The plane connects to other planes on both its long and short sides. For the purpose of creating a parklet, bulb out, or median refuge island on a street, the planes connect to one another on their long edge, as shown on the right, to create a new ground plane above the street.

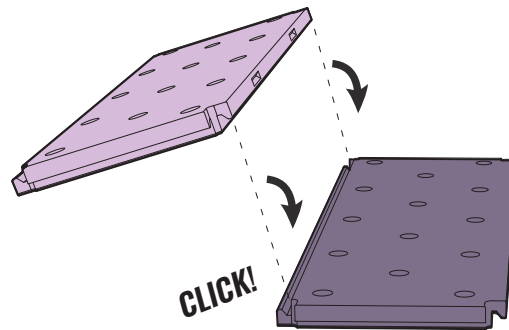

---

## Plane to Pedestal

The planes require the support of adjustable pedestals beneath them on the street. To set up a parklet, bulb out, or median pedestrian island, pedestals are placed in a grid on the street first, and then the planes are placed one at a time on top of the grid of pedestal supports. The first set of pedestals that support one plane should be used as a test to see how high to adjust the pedestal height against the height of the curb. Pedestal height is adjusted by spinning the top piece left and right. All pedestals should be adjusted to a level that enables the top of the plane to match the curb's height, the result being a flat surface from plane to sidewalk.

### Parklet

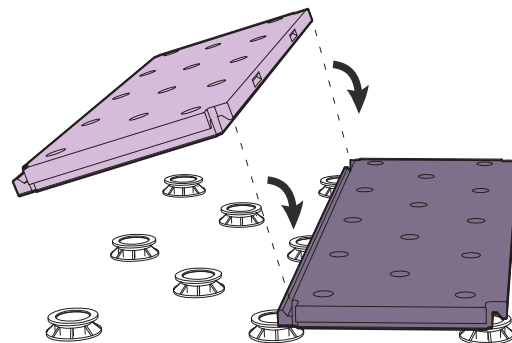



## Post to Parklet Bracket

The parklet railings are formed by screwing in 2 posts to brackets on either side using the cap and screw system. Two people are required to set up a parklet railing, by first positioning the post to match the post's cap with the bracket hole, then the screw is used to fasten the post to the bracket. The posts get screwed to the bracket in 4 places, as shown on the right.

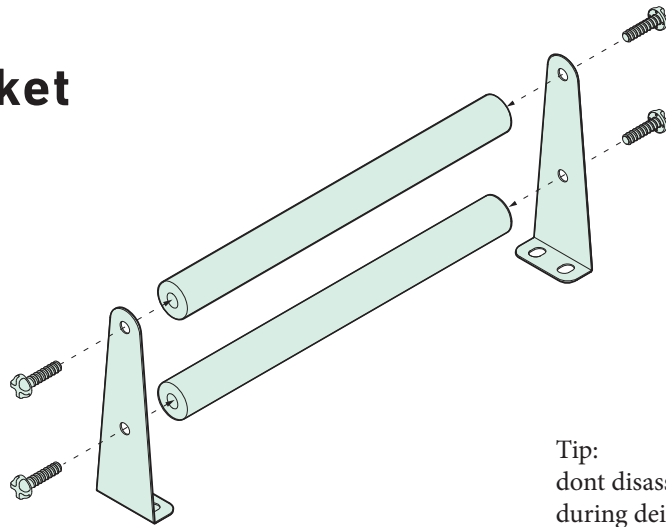

Tip:  
don't disassemble the railing during deinstall.

---

## Plane to Parklet Railing

After the parklet railings are assembled, they need to be fastened down to the planes that form the parklet. Placing a cap underneath the planes where the railing bracket holes are positioned, you then fasten the screw down through the railing bracket to thread into the cap underneath the plane surface. As shown in the diagram to the right, the order is screw - railing bracket - plane - cap.

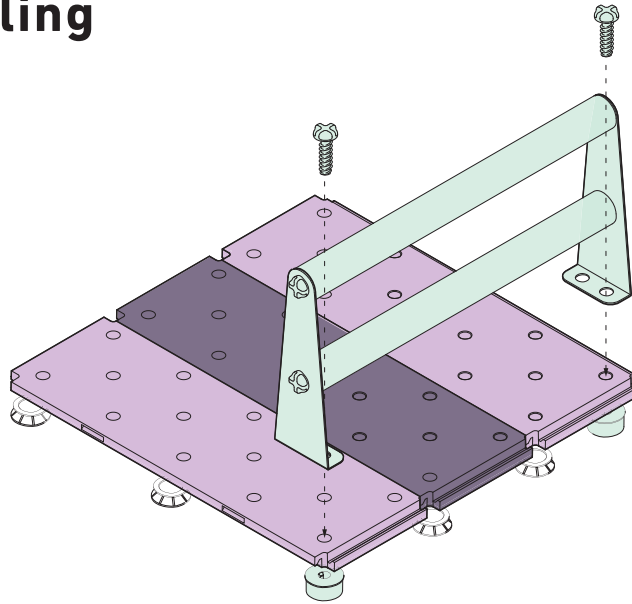

---

## Post to Bike Lane Bracket

The bike lane separator railing is formed by a single 6' post connected to two wooden brackets. Using the cap and screw system, affix the post to the wooden bracket on either end.

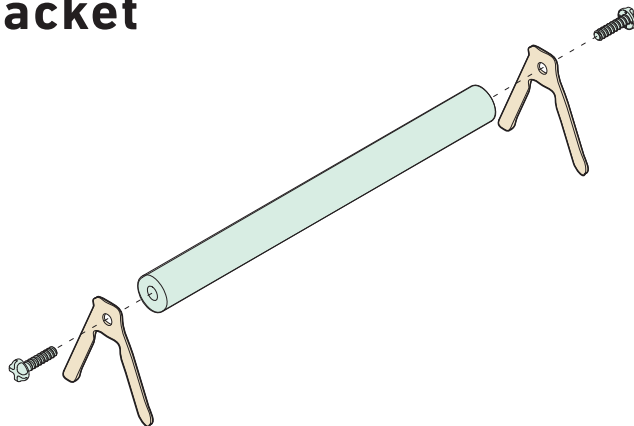

# BASIC ASSEMBLY / CONNECTIONS

---

Continuing from the previous page, the basic assembly and connections for the parklet table, bike lane flag bollards, and taping of the mesh elements, are detailed below.

## Table Top to Post

The parklet tables are formed by screwing together the table top to its 30" leg posts. First set up the 4 posts in a square configuration, placing the table top over the posts, so that the post and table top holes align, and then securely tighten the screws.

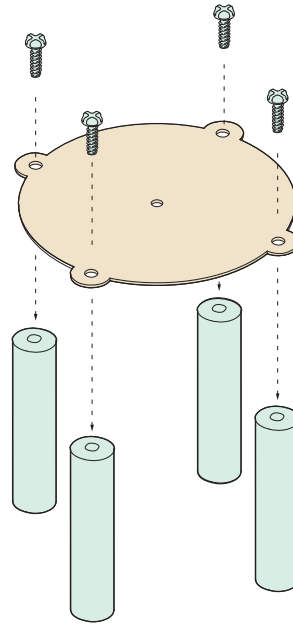

---

## Flag to Bollard

The separated bike lane bollards are assembled by inserting the flag pole into the bollard's flag stand and then securely tighten the screw.

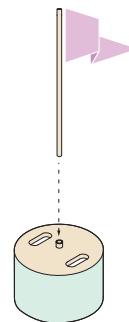

# Tape Down

## Do

Tape down all edges of the mesh square evenly.

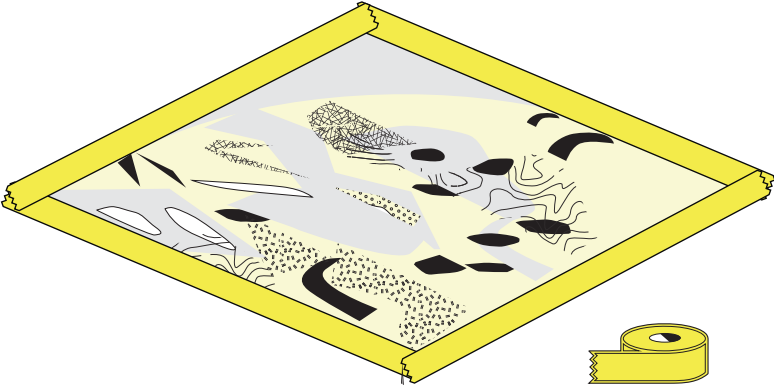

---

## Don't

Leave gaps where there is no tape, or put excess tape at the corners.

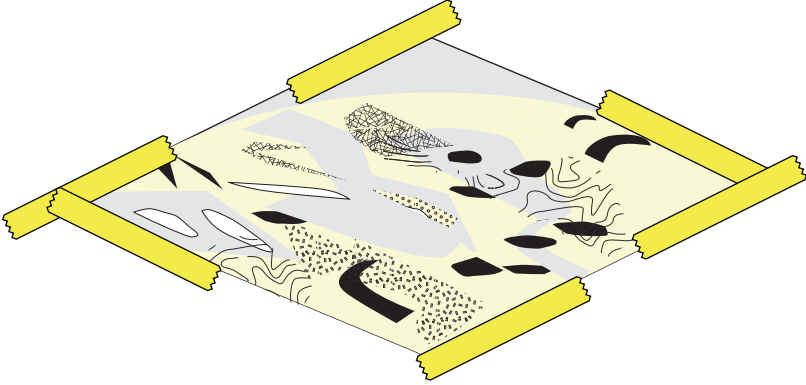

---

## Don't

Tape down just the edges.

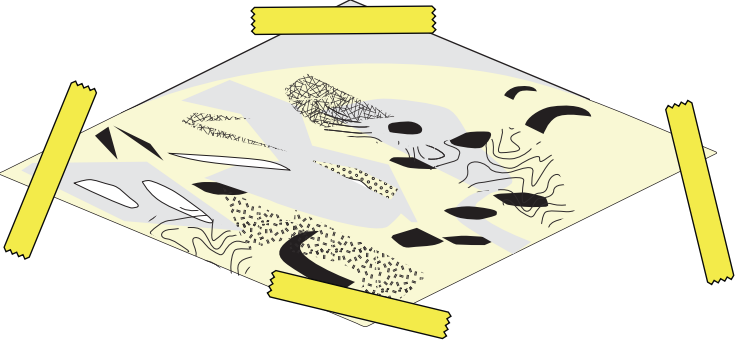

**Creative  
Crosswalks  
promote pedestrian  
safety with high  
visibility designs  
that are functional  
and artistic.**

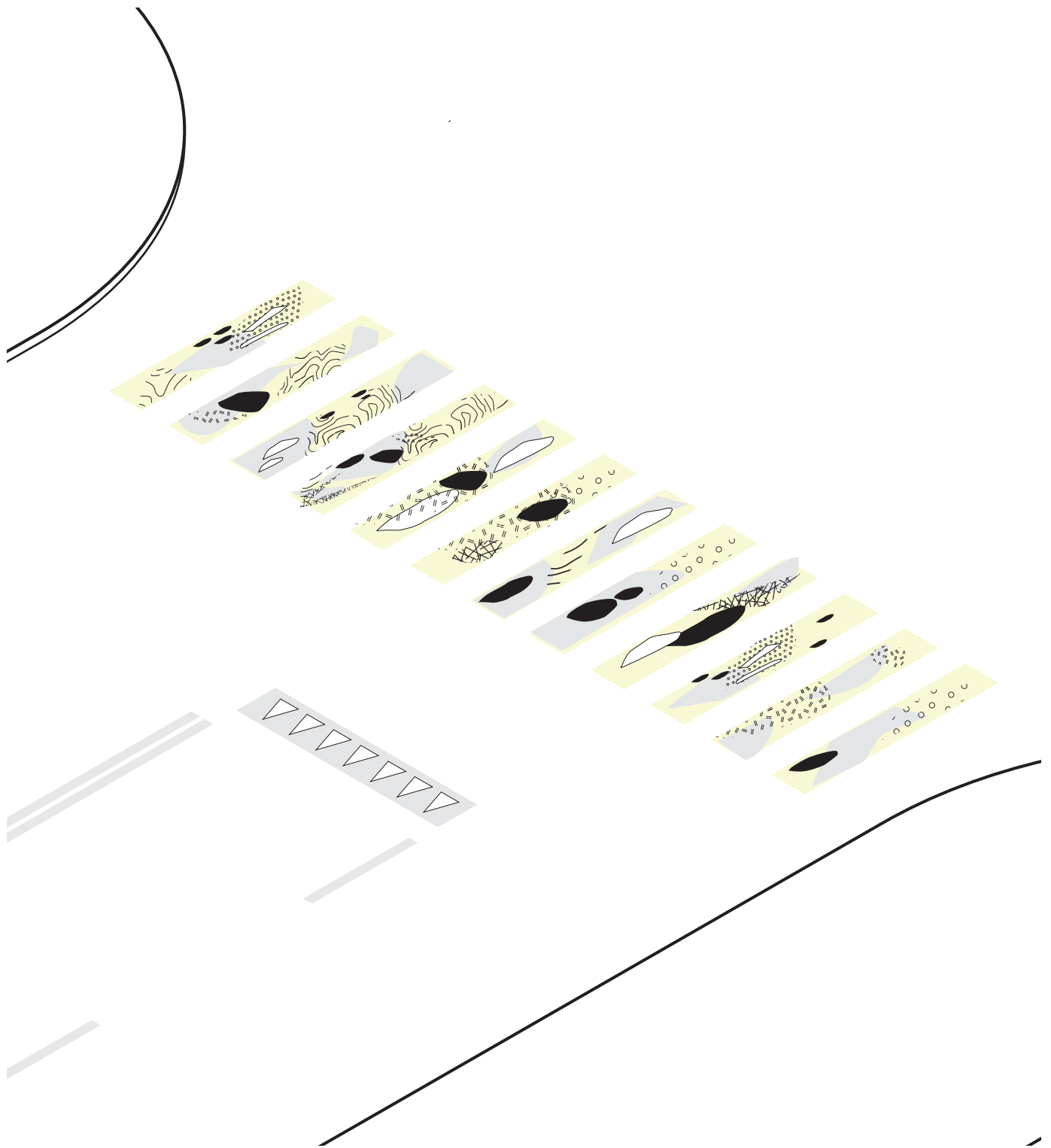

Fig. 01: Creative Crosswalk Diagram

# CREATIVE CROSSWALK

---

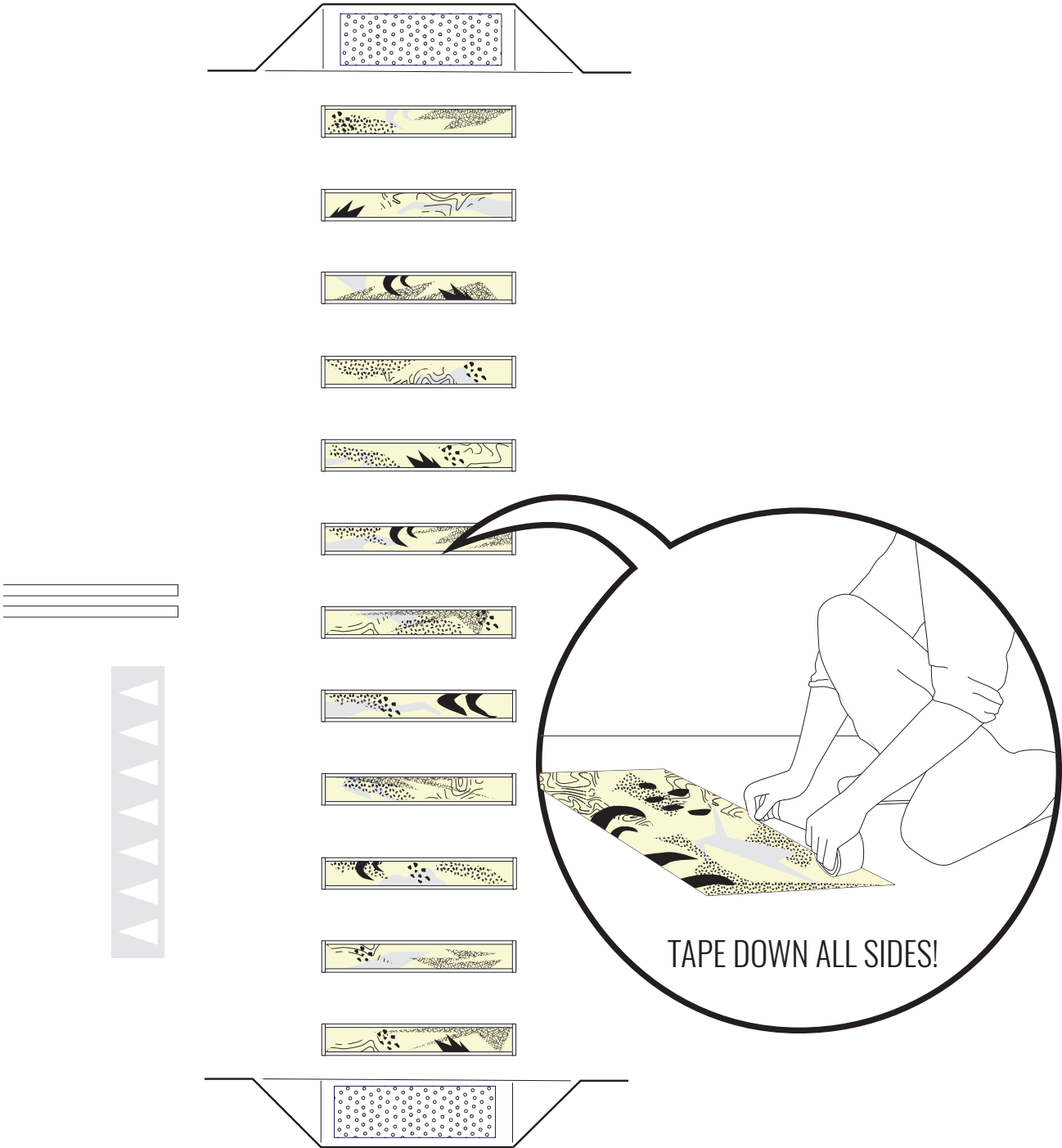

Fig. 01: Creative Crosswalk Plan Diagram

## Set up

The Creative Crosswalk is installed through taping down individual strips. If a crosswalk already exists at that location, install the artistic strips in the space between the white stripes.

To start, ensure that installation can take place without interference from car traffic. We recommend laying out all of the strips where you would like them to be, evenly spacing them with a tape measurer (included in the Kit), and then once in place, using the yellow tape to tape down the strips on all of its sides.

## Maintenance

To clean the mesh strips of the creative crosswalk, mop them down with the cleaning fluid in the Kit.

The yellow tape will need to be replenished. Contact Scag if there are less than 4 rolls of tape.

## Specs

Dimensions : 11 ft x Varies

Individual strips : 11' x 3'

Advised Number of Installers: 4

Estimated Install Time : 45 mins

## Inventory

3'x11' Vinyl Mesh Strips: 12

2'x11' Sharkstooth: 1

Design Treatment Sign: 1

2" Yellow Flooring Tape

**Separated Bike  
Lanes create more  
space between cars  
and people on bikes,  
improving safety  
and comfort for  
everyone.**



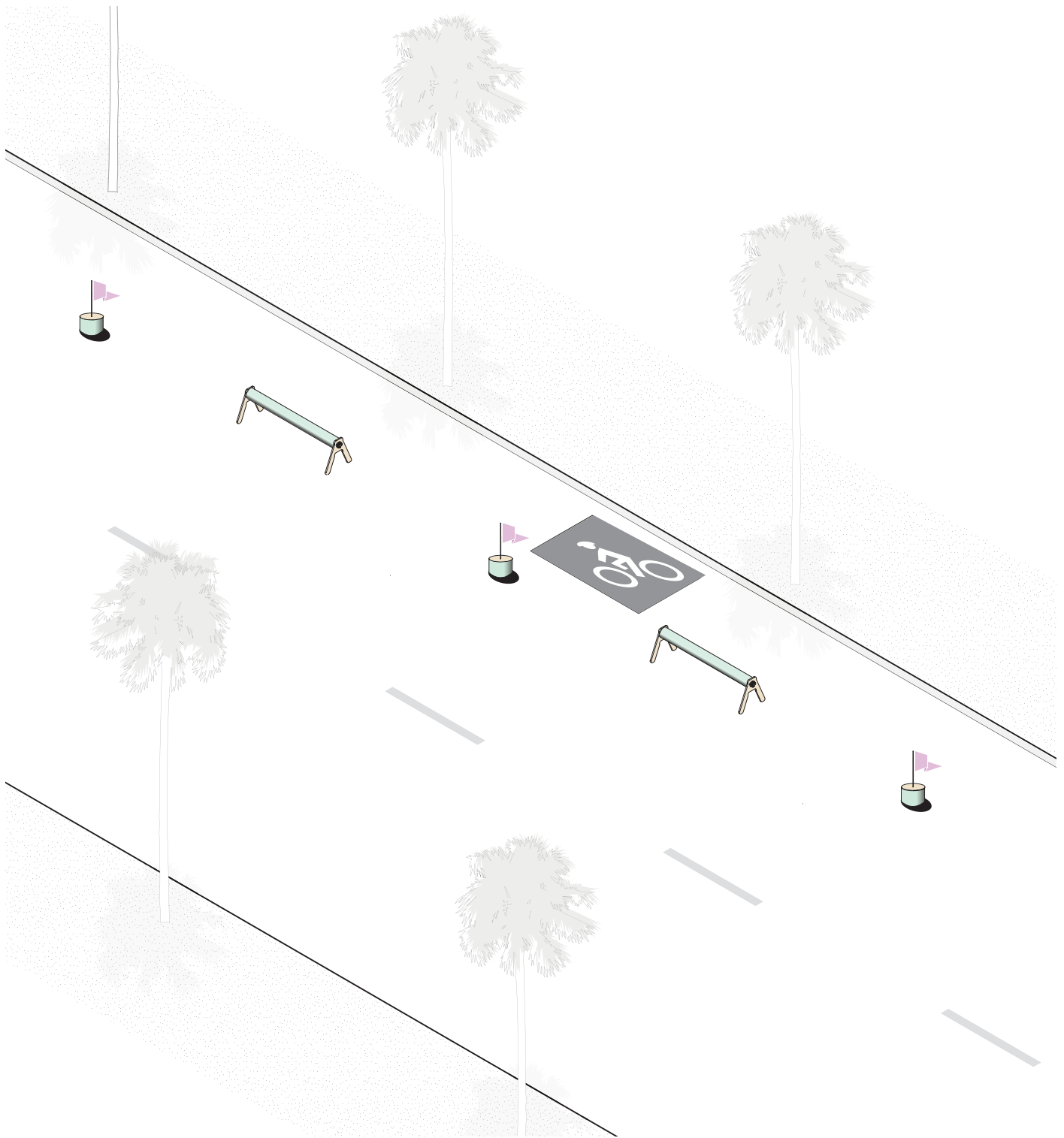

Fig. 02: Separated Bike Lane Diagram

# SEPARATED BIKE LANE

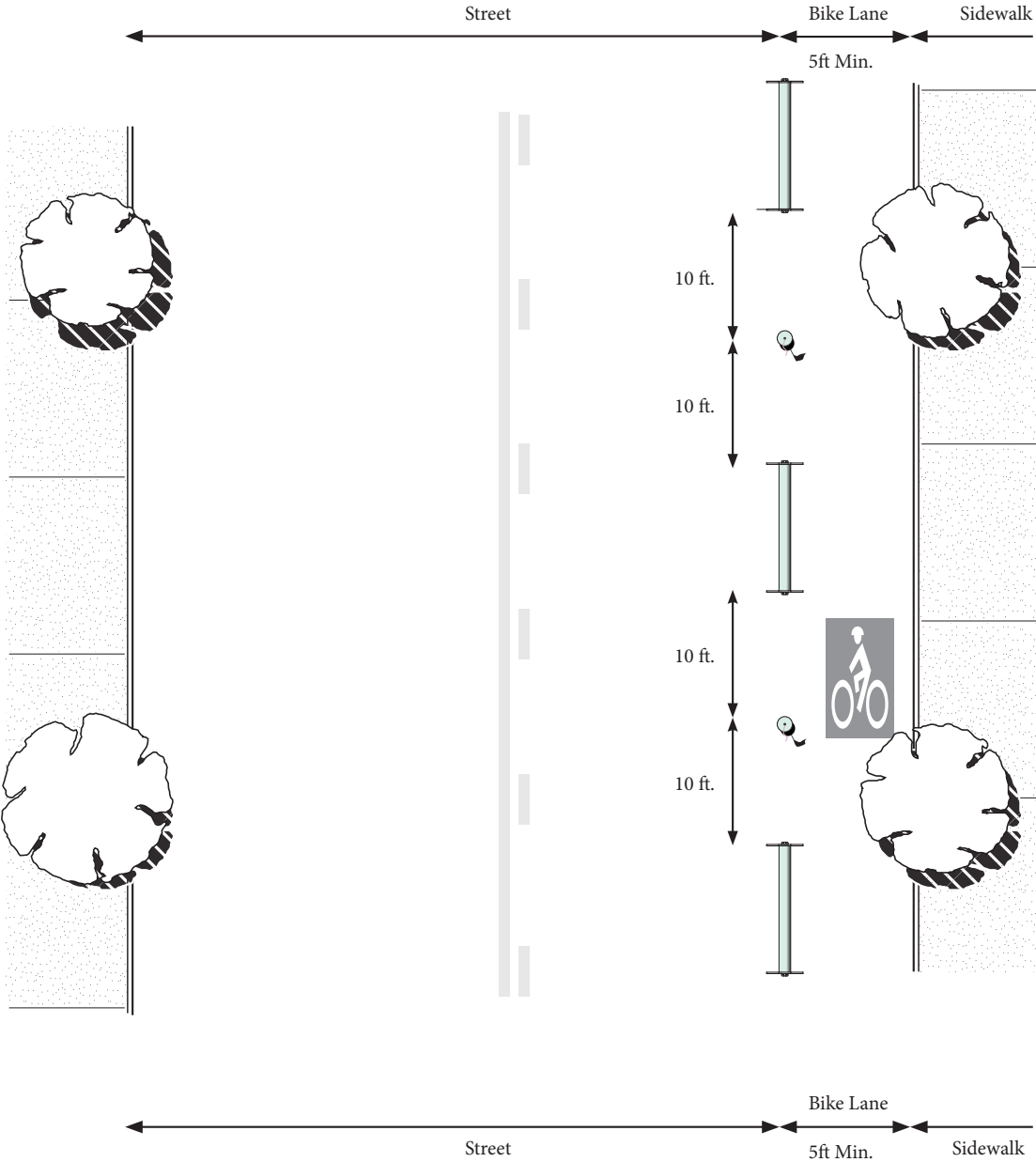

Fig. 03: Separated Bike Lane Plan

## Set up

To install the separated bike lane treatment, alternate bike lane railings and bollards at 10 ft. intervals parallel to the curb. Near a cross street, tape down the bike lane marker in the bike lane, as shown in the Bike Lane diagram.

## Maintenance

Use a rag and cleaning fluid to clean the mesh bike lane square and wipe down the bike lane railings.

## Specs

Dimensions : 5 ft min x 520 ft  
Advised Number of Installers: 2  
Estimated Install Time : 45 mins

## Inventory

Bike Lane Vinyl: 1  
Bike Lane Railings: 20  
Bike Lane Bollards: 20  
Design Treatment Sign: 1  
2" Yellow Flooring Tape

**Curb Extensions  
or bulb-outs, make  
crossing the street  
shorter, safer, and  
easier. They narrow the  
street, slowing down  
traffic to keep everyone  
safe.**



# CURB EXTENSION

---

## Set up

The Bulb out consists of two sets of interlocking planes that extend the sidewalk on both sides of an intersection corner and are connected by mesh circles that fill the empty space in the intersection between them (see “Fig. 04: Curb Extension Plan Diagram” on page 21).

To start, ensure that installation can take place without interference from car traffic. Begin by placing the pedestals down where you want the first bulb out to begin. Align the

pedestal height so that the plane sits flush with the curb and sidewalk. After placing down the pedestals and connecting the planes on top of them, add the mesh end piece and stanchions, as shown in the diagram below. Repeat this same process for the second bulb out around the corner on that same intersection.

In the space between the two bulb outs, place the circles down so they are spread out evenly across the space, then tape each one down to the street.

## Maintenance

To clean the planes and mesh end pieces and circles, mop them or wipe down with rags using the cleaning fluid included in the Kit.

## Specs

Dimensions : (2) 6 ft x 23 ft

Advised Number of Installers: 2

Estimated Install Time : 30 mins

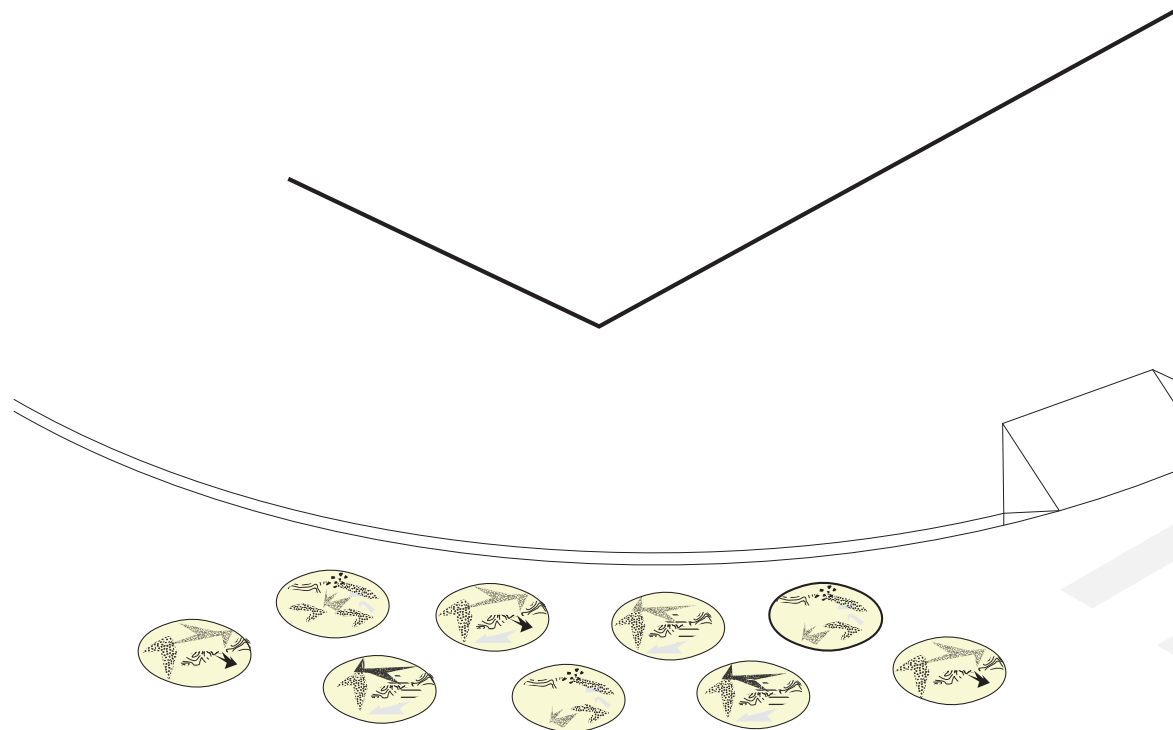
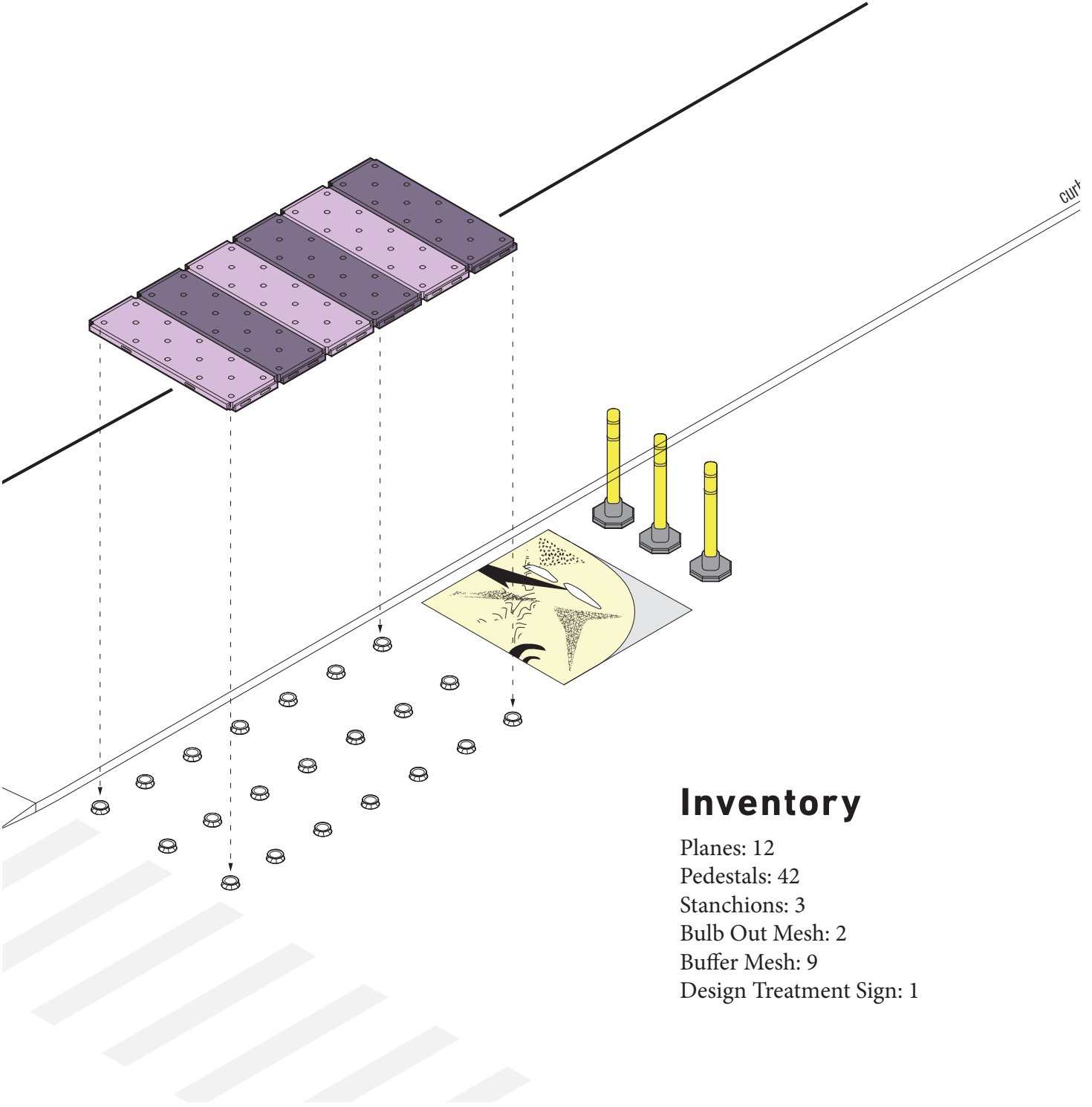

Fig. 05: Curb Extension Diagram



## Inventory

- Planes: 12
- Pedestals: 42
- Stanchions: 3
- Bulb Out Mesh: 2
- Buffer Mesh: 9
- Design Treatment Sign: 1

**Parklets are tiny  
street plazas  
that extend the  
sidewalk and  
create more space  
to eat, relax and  
hang out.**



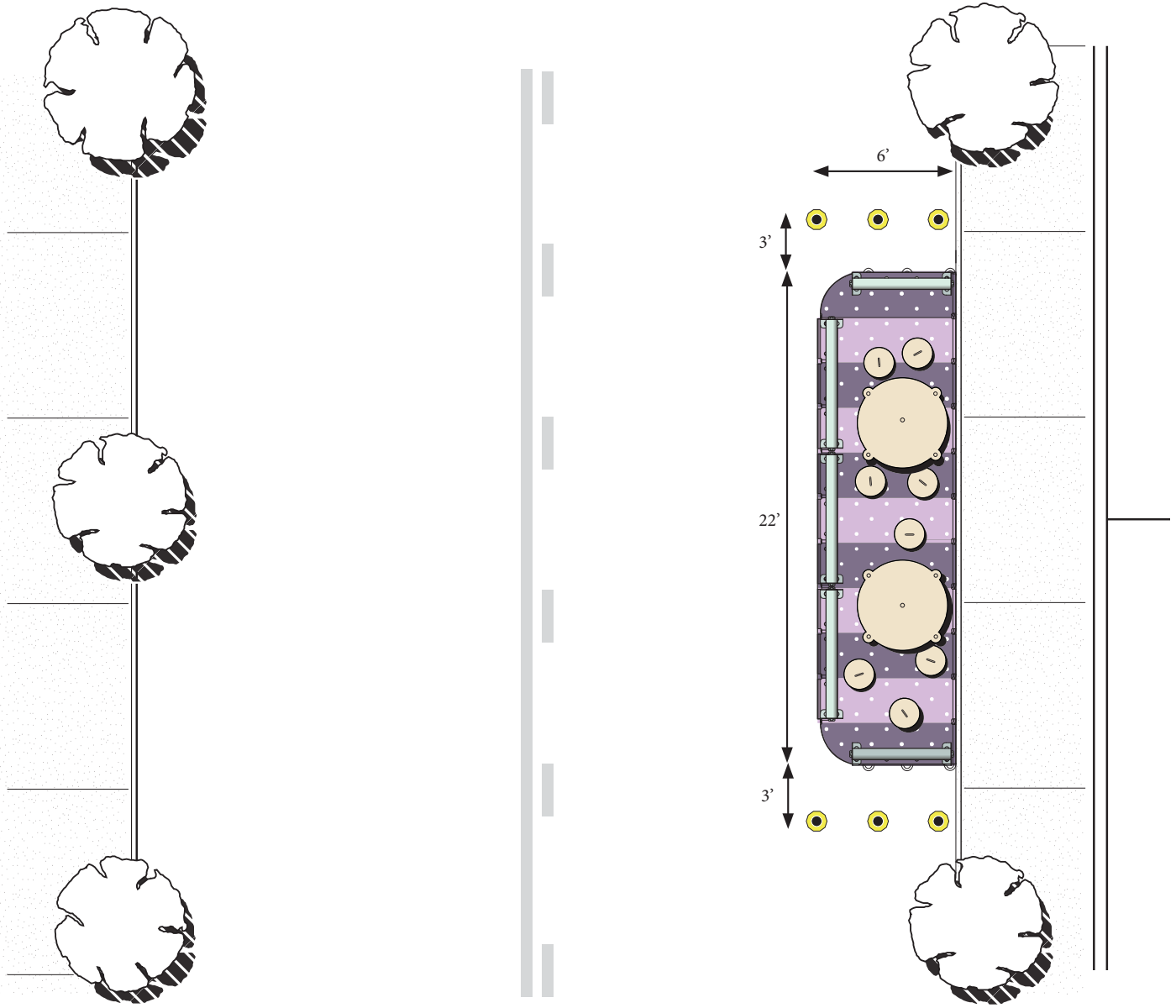

Fig. 06: Parklet Plan Diagram

# PARKLET

## Set up

First, mark off a 22 feet space where the parklet is to be located. Once a designated space has been chosen, begin by placing pedestals down in a grid that will support the planes.

Ensure the pedestals are set to a level that allows for a flat surface from plane to curb to sidewalk. Continue setting down pedestals and connecting planes on top of the pedestals.

Once the planes are set up, connect the small and large railing brackets down to the plane, using caps and screws. The caps should be placed under the planes, to connect the brackets and planes.

Finally, assemble the tables and place the tables, umbrellas, stools, and fake plants on the parklet.

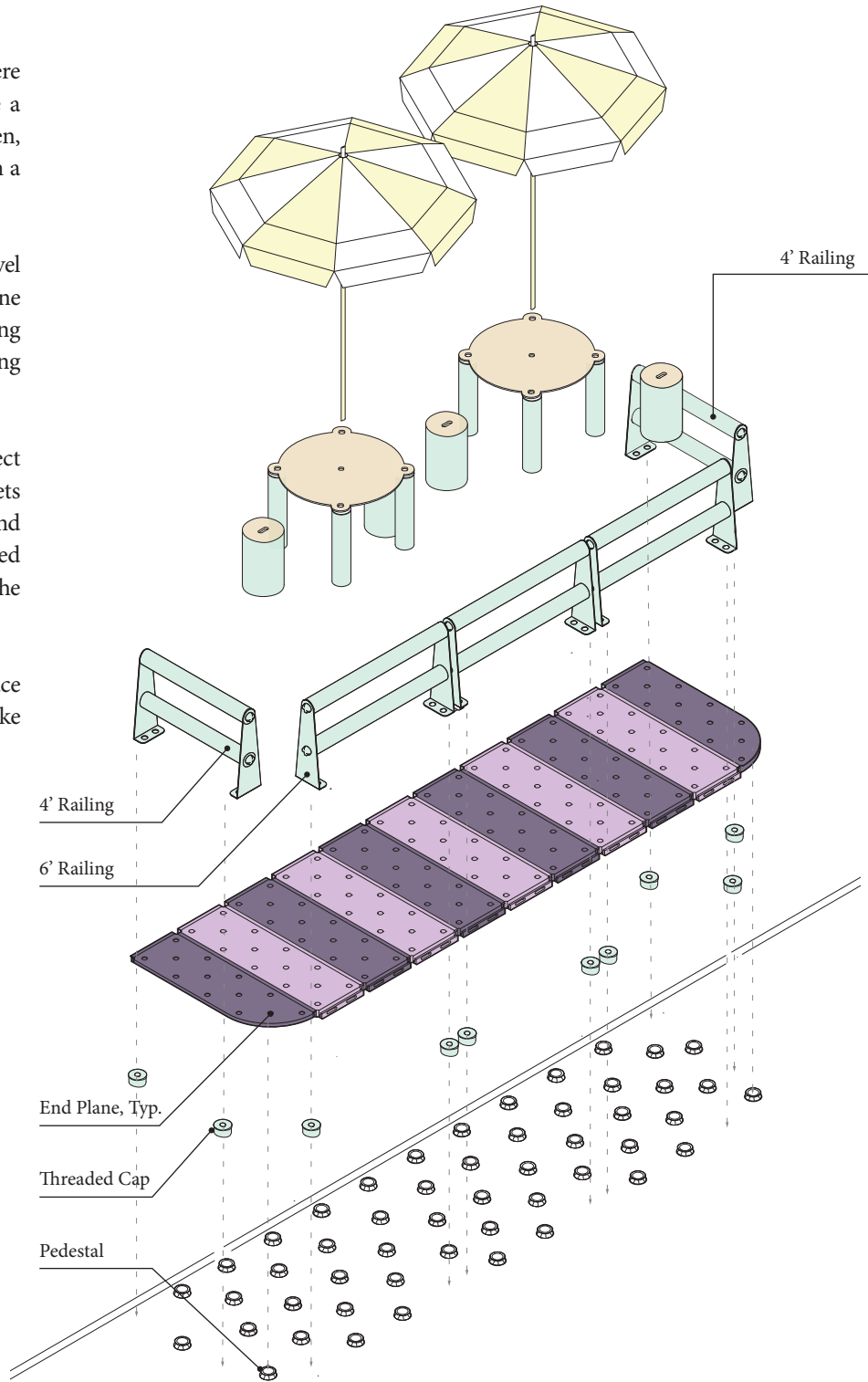

Fig. 07: Parklet Assembly Diagram

## Maintenance

To clean the planes of the parklet, mop them using the cleaning fluid included in the Kit. To clean the railings, wipe them down with rags and the same cleaning fluid.

## Specs

Dimensions : 6 ft x 24 ft

Advised Number of Installers: 2

Estimated Install Time : 25 mins

## Inventory

Pedestals: 54

Planes: 9

End Planes: 2

Long Railings: 3

Short Railings: 2

Tables: 2

Bollards: 8

Umbrellas: 2

Umbrella stands: 2

Caps: 6

Screws: 10

Stanchions: 4

Design Treatment Sign: 1

**Median Refuge Islands are protected spaces in the center of the street that shortens the crossing distance and exposure to traffic for a bicyclist or pedestrian. Refuge Islands also calm traffic by narrowing the roadway.**

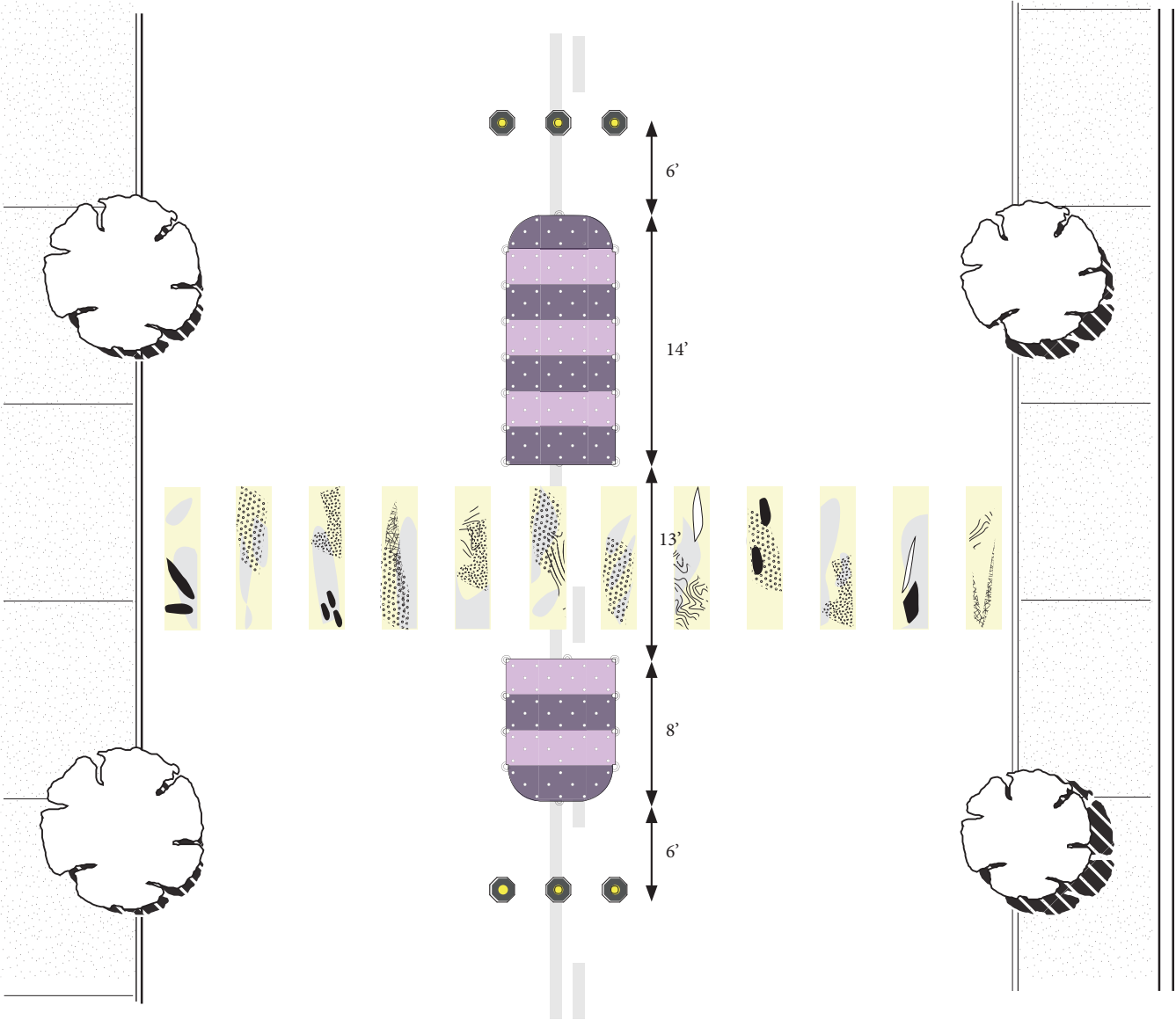

Fig. 08: Median Pedestrian Refuge Island Plan Diagram

# PEDESTRIAN REFUGE ISLAND

## Set up

The median pedestrian refuge island is assembled using a combination of pedestals, planes, and stanchions.

To begin, choose a part of the street where you would like to place the median island, and begin placing

pedestals down so that the middle of the planes align with the center of the street. On either side of the planes that interconnect, place the wooden nose planes, according to the diagram below.

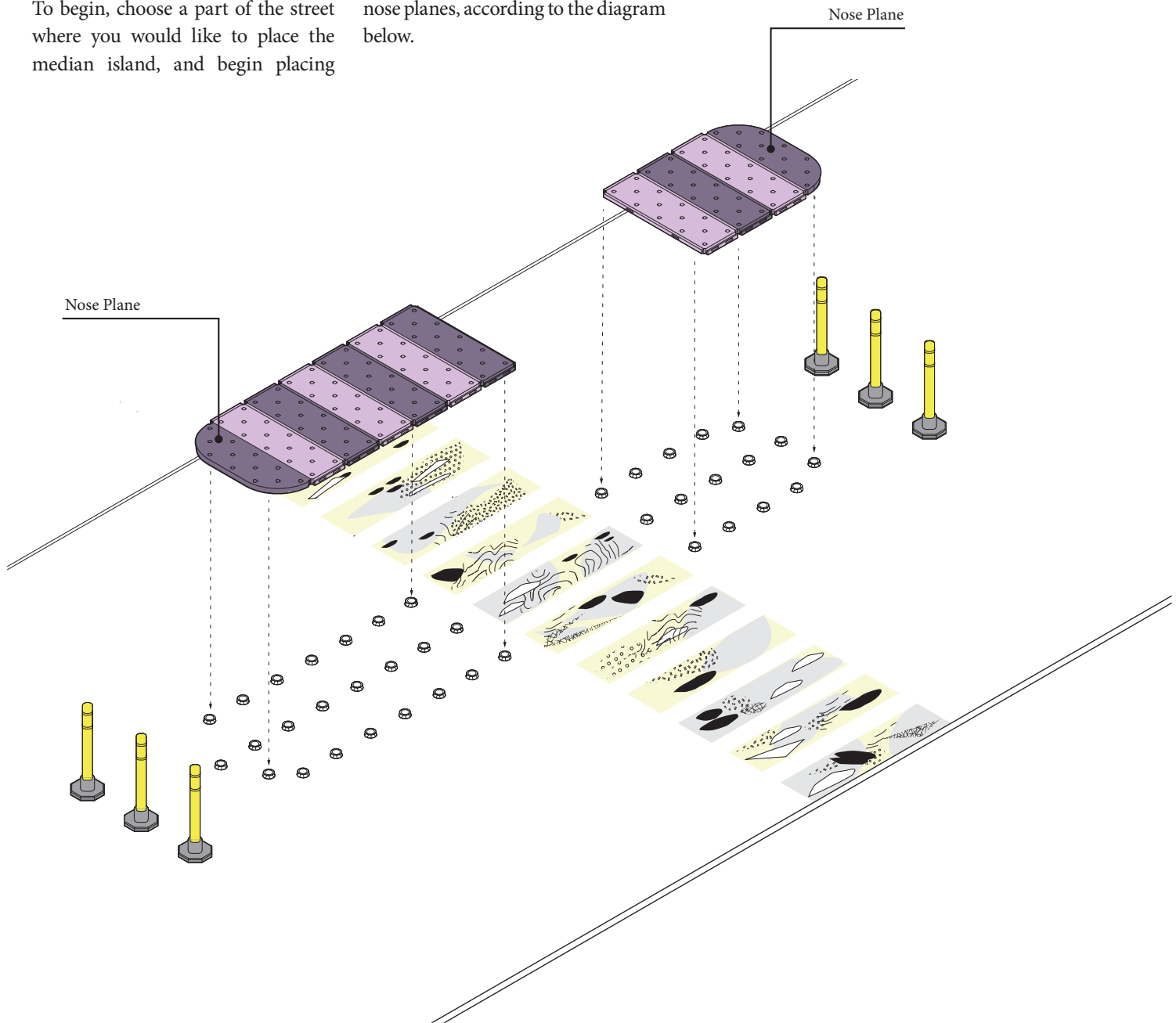

Fig. 09: Median Refuge Island Assembly Diagram

## Maintenance

To clean the planes of the refuge island, mop them down using the cleaning fluid included in the Kit.

## Specs

Dimensions : 6 ft x 47 ft  
Advised Number of Installers: 2  
Estimated Install Time : 20 mins

## Inventory

Pedestals: 39  
Planes: 9  
Nose Planes: 2  
Stanchions: 6  
Design Treatment Sign: 1

# KOP STORAGE AND TRANSPORT CONSIDERATIONS

---

## A LA CARTE

If you are considering leasing just one or several of the design treatments, you will need to contact Julia Lippe-Klein with SCAG to discuss availability and terms of use. Please contact Julia at least 2 weeks prior to the event. Items can be picked up at

Los Angeles Self Storage located in Downtown Los Angeles between the hours of 9am - 4pm Monday -Friday. The applicant will be required to coordinate delivery. We recommend renting or borrowing a 16ft truck.

## SCAG

Southern California Association of Governments  
Julia Lippe-Klein  
213-236-1856  
lippe-klein@scag.ca.gov

Pick up Address:  
Los Angeles Self Storage  
1000 W 6th St, Los Angeles, CA 90017

\* SCAG does not assist with loading or unloading any of the design treatment pieces. Applicant is required to provide assistance.

\* Requires a 16' truck or truck rental for both pick up and drop off

\* Requires coordinating delivery and pick up with Scag staff two weeks in advance



# ALL TREATMENTS

If all 5 design treatments are requested and you have access to storing a 7.5 ft x 16' x 7.5' container at the event location, the Kit of Parts can be delivered to your site. This will require that you coordinate both delivery and pick up with a Pack Rat

representative 3 weeks prior to the event. Once the container is delivered it will remain in the drop off location until the scheduled pick up. Delivery and pickup times are imprecise, so please consider the possibility that delivery and/or pickup may take

place a day prior to or after the event. Delivery and pick up services are not available on Sundays.

## Pack Rat

Luke Miller  
855-202-3901  
lmiller@1800packrat.com

- \* Requires coordinating delivery and pick up with Packrat staff three weeks in advance
- \* Container stays on site where it is dropped off
- \* Delivery fee varies due to site location.
- \* Pack Rat container number is XLD05653

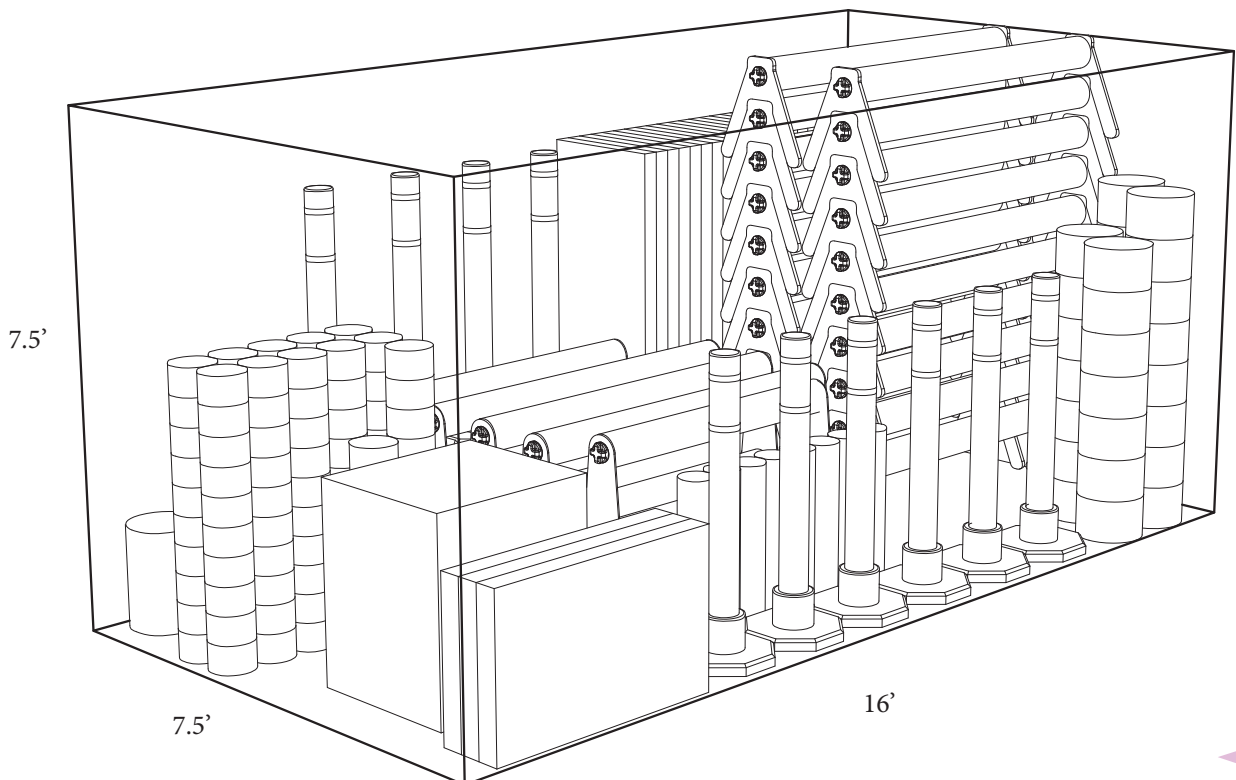

# CONTACTS

## Pack Rat

Luke Miller  
855-202-3901  
lmiller@1800packrat.com

## SCAG

Southern CA Association of Governments  
Julia Lippe-Klein  
213-236-1856  
lippe-klein@scag.ca.gov

## KDI

Kounkuey Design Initiative  
Jessie Heneghan  
213-537-0031  
jessie@kounkuey.com